

Article number: 01020811

Description: Retaining ring J68 DIN472
Stainless 411

Measures

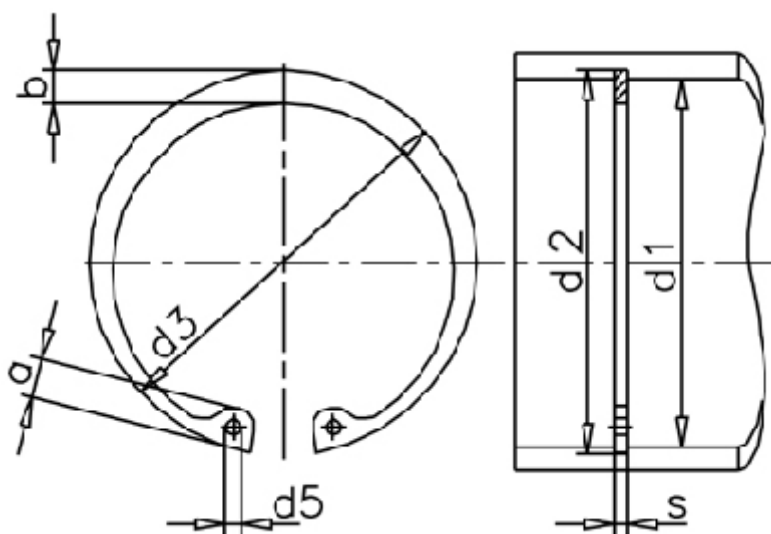

a max	= 7.8	FN kN	= 56.20	t	= 1.50
AN mm ²	= 337.0	FRg kN	= 21.0	tol	= +0,30
b	= 6.1	FR kN	= 119.0	tol	= +1,10-0,46
d1	= 68	g	= 2.5	tol	= -0.07
d2	= 71.0	K kN-mm	= 218.0	Tong	= ZGJ-3
d3	= 72.50	m min	= 2.65	Weight kg/1000	= 16.00
d5 min	= 3.0	Nominal drive	= 4.5		
Description = J 68		s	= 2.50		